

EasyLoader

AV-3044 PRO SMS

(Large for LCD keypads)

**Integrated Alarm Control panel &
Communicator 4 or 8 zones**

SMS Enabled

Installation and Operation Large Manual

Version 1.06A

Edition I

This product is subject to continuous enhancements and therefore specifications may be changed or altered without prior notice

Item: 4785E_PRO (A3BKE)

Rev 01: 15-June-2012



Table of contents

Introduction AV-3044 Pro	3
Tips to first time installer.....	3
Keypad short description.....	4
Revision changes.....	5
2. Wiring devices to the panel.....	5
2.1 Zone Wiring.....	5
2.2 AV-3044 PRO Eight Zone Panel Zone Wiring.....	6
2.3 Keypad Wiring.....	8
2.4 Siren Wiring.....	9
2.5 Remote Indication Terminals.....	10
2.6 Remote Indications Testing.....	10
2.7 Grounding Wiring & Lightning Protection.....	11
2.8 Back-Up Battery.....	11
3. Telephone Line and Central Station.....	12
3.1 Telephone Line & GSM Wiring.....	12
3.2 SVM – Synthesized Voice Module.....	13
3.3 Answering Machine Bypass.....	13
3.4 Telephone Line Test.....	13
3.5 Contact ID Format.....	13
3.6 ID Codes for Communicator.....	14
3.7 Remote Up and Download.....	14
4. Remote DTMF and remote Arming.....	15
4.1 Remote Key and Wireless Arming & Disarming.....	15
4.2 Remote Access via DTMF.....	16
4.3 DTMF Commands.....	17
5. System Codes.....	18
5.1 Description of main codes.....	18
5.2 Set New User Code.....	18
5.3 Installer Programming mode & Code change.....	19
5.5 Auto Arming.....	19
5.6 Restore default codes.....	20
6. LCD Keypad.....	20
6.1 Hold-Down Functions.....	20
6.2 Group Bypass (home mode).....	22
6.4 LCD Dual Keys Functions.....	23
6.5 Keypad Functions at location 200.....	23
6.6 Keypad Sounder.....	25
6.7 LED Indicators.....	26
7. New address at series 3000.....	27
7.1 Systems parameters address.....	27
7.2 Telephone and SMS address.....	28
7.3 Events reported by the SMS module.....	29
7.4 Dialer reporting Programming locations.....	31
8. Programming Sheet Version 1.06.....	32
8.1 Step - By - Step Programming.....	37
9. Powering Up & Wiring Diagram.....	39
9.1 Before Powering Up.....	39
9.2 Wiring Diagram.....	40

Introduction AV-3044 Pro

This is a full manual for series 3000 alarm panels supplied as reference (not with panel). AV-3044 Pro is compatible with Av-Gad LCD keypads (AV-705, AV-706, AV-707).

Series 3000 communication and dialing options are by far improved compared to previous ones.

- Dials to four phone numbers, supports SVM-40 two voice messages
- Reports to two different central stations
- Sends SMS messages via PSTN (saves the SIM card and GSM fee) to four numbers
- Signal test to central station
- Set to 4 (w/o resistors) or 8 (with resistors) zones mode via address 200 commands

Notice the amazing fact that all messages that displayed on the keypad are sent by SMS without programming; if the keypad text is "Zone 3 Main room" during alarm the SMS received by user quoted as "alarm Zone 3 Main room". After 1st power up if text not displayed correctly get into programming mode, enter 200 than 71 than #, notice Download Text message, proceed; now your keypad is synchronized with the alarm panel. LCD and SMS texts are available in few languages: English, German, Italian, French, Finish, Spanish, Swedish, etc.

Series 3000 been revised for higher security when using remote PC and remote DTMF in order to prevent criminal system tampering. Pay attention to new default settings.

AV-3044 Pro provides on site selecting four or eight zones (8 zones requires resistors) via keypad. The preferred programming way is by keypad.

Tips to first time installer

If you are a first time installer, do not hook up any remote sensors at first. The most common confusion comes about when the **alarm will refuse to arm**, because a zone is "troubled". Complete the power supply, siren, keypad and strobe wiring, and for the moment connect ALL the zone terminals to -V, (by default panel is 4 zones). This will simulate a system with all zones looped out through closed switches. The alarm is supplied already programmed with an "average" list of settings (default) and can be used straight away, a few of the program locations may have to be changed to suit the actual sensors and output devices used.

- 📖 Read this manual and LCD keypad manuals carefully, it looks complicated, but all the information is there
- 📖 Do not power up with battery! Use the AC power for start and testing
- 📖 To start with: Hook up the keypad, connect all zones to -V or apply resistors for 8 zone mode, power-up by applying AC only
- 📖 In case the keypad displays 'garbage' verify the minus (-V) wire and other keypad connection
- 📖 Arm and disarm the system, when the Status LED light (not blinking), enter your master code; 1234 & #
- 📖 Try the hold-down functions. Hold each key for approximately 2 seconds, press # (enter) to confirm the hold down command
- 📖 Set the system time by holding-down key '0' then '1', set time in 24H format, blinking 'Set Time' stop
- 📖 The default programming is set for siren alarm device that requires 12V to alarm (Bell Mode)
- 📖 Connect the strobe light to the SLO output (requires programming). The SLO supplies -V during alarm
- 📖 Make sure you are using the Earth terminal  for Grounding; it is not a minus terminal
- 📖 Typing six erroneous codes will lock the keypad keys for 30 seconds
- 📖 Fast test: Verify "Dial LED" Self Test at Initialization (STI) - Blinks for the first 50 seconds after power on, confirms panel is operative, from keypad wait to six beeps to confirm communication OK.

Keypad short description

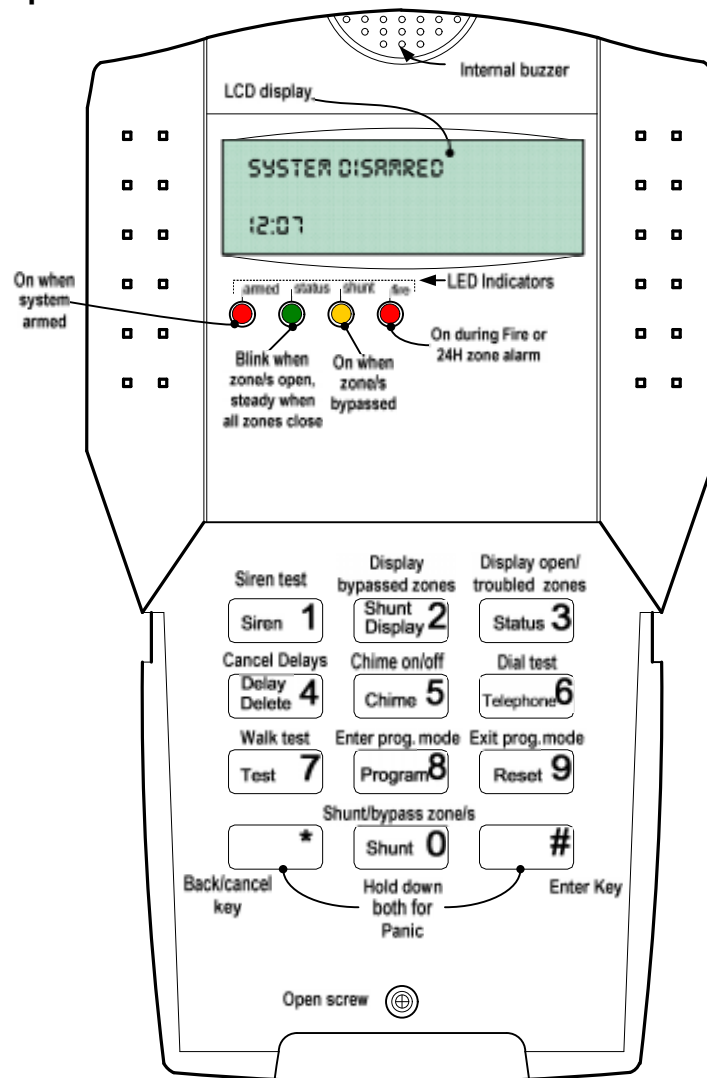

Figure 1: LCD keypad description

Common Terms in this Manual

- 'SHUNT' and 'BYPASS' are interchangeable terms
- Program Mode - Enables features programming, Programming is displayed, alarm is disabled
- Use Mode – System is disarmed and not in alarm or program mode
- AV-706, AV-707 or AV-707B is identical in operation
- LCD keypad: Press # (enter) to confirm

- Standard Keypad functions are accessed by pressing keys (short press). The 1 to 0 keys used for Arming/Disarming (ON/OFF), Zone Shunt (Bypass) and other programming functions.
- A short beep confirms each key press.

A short press on keypad key accesses the following special functions:

- Chime 5 Instant Arming, by pressing key '5' (requires programming).
- Shunt 0 Zone Bypass, by pressing key '0,' followed by entering the Zone number/s

Group Bypass: For full details refer to the keypad section in this manual and the LCD keypad manual.

The AV-707B provides arming and group bypass by pressing two keys (refer to keypad manual).

Revision changes

Date	Version	Contains
11 April 2012	1.05	4 numbers for SMS, 4 numbers for PSTN dial
11 April 2012	1.05	Add address 097; SMS sending trials
12 May 2012	1.06	select 4 or 8 zone via address 200
12 May 2012	1.06	Added Pulse count zones for outdoor detectors
12 May 2012	1.06	Contact ID is default for CS report
17 May 2012	1.06	Panel name revised to AV-3044 Pro (was AV-3048)

Electronic Fuse Overview

The Electronic Fuse device included as a series element in electric circuit. In response to an over current it protects the circuit by going from a low-resistance to a high-resistance state that reduces the current to a level that's safe for the circuit elements. The change in resistance is the result of a rapid increase in the temperature of the device. Like traditional fuses, Electronic Fuse devices interrupt the flow of dangerously high current. However, unlike traditional fuses, they automatically reset after the fault cleared and power to the circuit removed. Because they are solid-state, Electronic Fuses are also better able to withstand mechanical shock and vibration, and provide reliable protection in a wide variety of applications. In case of over current, carefully touch the fuse body (yellow round disc), hot body means the Electronic Fuse in protection mode, disconnect the load and wait 2-3 minutes until the fuse body get cooler.

2. WIRING DEVICES TO THE PANEL

2.1 Zone Wiring

Your system provides few ways of zone wiring: Non EOL resistor loop, EOL resistor loop. The EOL loop protects the zone lines against tampering. It's recommended to use the EOL mode; it's safer and keeps lower EMI and RFI interference.

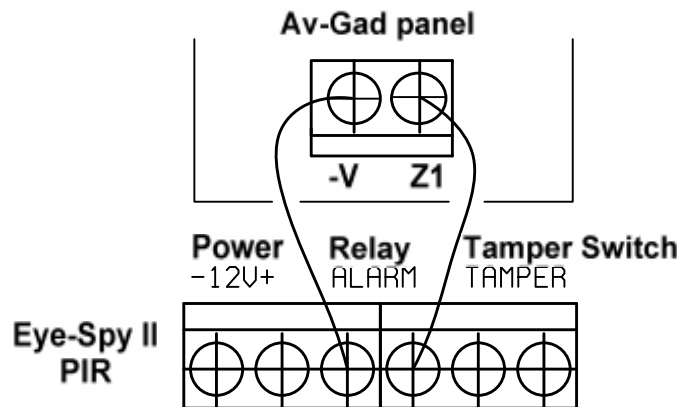

Figure 2.1: None EOL mode zone wiring to PIR

Via programming, select either End-Of-Line (EOL.) resistor protection, or non-EOL mode.

The EOL is defined at address 029; the default program is set at non-EOL for all zones. To select EOL mode enter at address 029 the required zone to be EOL, or enter '0' to enable all zones as EOL.

Note: Address 029 at the AV-3044 at 8 zone mode is blocked. Only EOL mode is available.

If EOL mode is selected better install the EOL resistor (2.2K/0.25 or 0.5W) inside the detection device (e.g. PIR, Magnetic Switch).

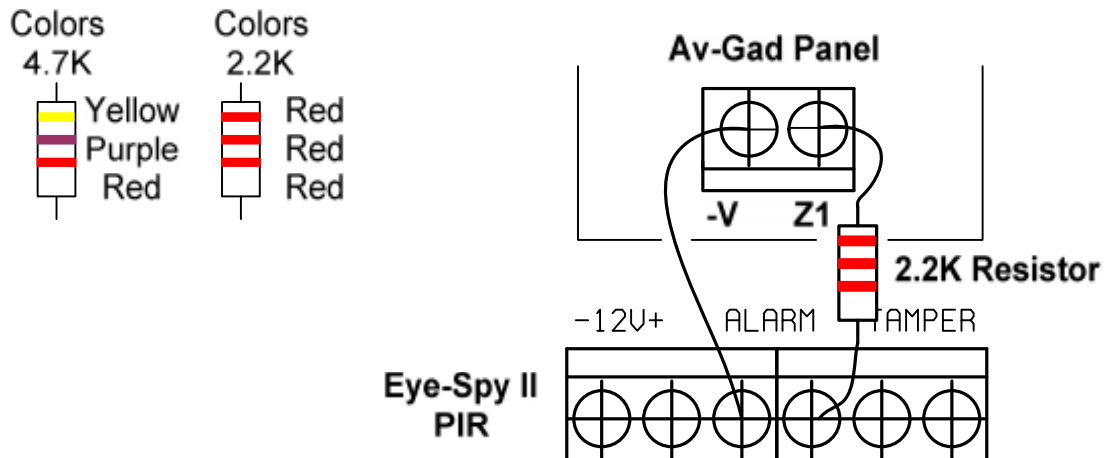

Figure 2.2: EOL mode zone wiring (in four zone mode)

Maximum zone wiring length is 200 meters using 0.5-mm² wires, EOL mode wiring is highly recommended.

Note: 'Zone' and 'Sector' are interchangeable terms in this manual.

Always use EOL resistor, to prevents EMI and RFI interference and higher security

An EOL zone will report Tamper alarm in case of zone shorting (if it has been EOL programmed). For connecting N.O. zones, programming is required, refer to address 042. Do not connect few sensors to one zone in EOL mode.

2.2 AV-3044 PRO Eight Zone Panel Zone Wiring

The AV-3044 Pro board carries a specific identification label (refer to wiring diagram) that shows the version and panel type.

The AV-3044 Pro works in 4 or 8 zone mode according to your setting (see 200 address commands), if 8 zones selected EOL mode is a must (can't work in none EOL), it means always using EOL resistors. The zones are referred to -V. Connect two wires to the same terminal, one wire in series with the 2.2.K resistor and the sensor contacts (relay), the other wire in series with 4.7K resistor and other contacts.

Tamper alarm per zone at 8 zones mode is not available with AV-3044 PRO.

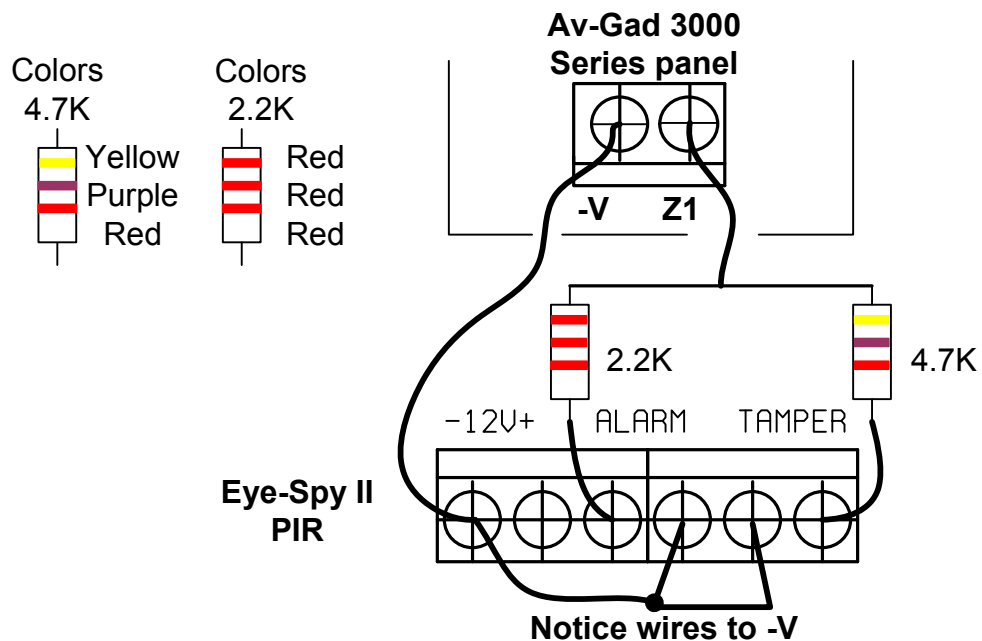

Figure 2.2: EOL mode zone wiring (in four zone mode)

The 2.2K resistors are wired with the odd zones (1, 3, 5, 7), the 4.7K are wired with the even zones (2, 4, 6, 8) as table below shows, for latest AV-3044 PRO starting version 1.05.

Terminal wire No.	Resistor 2.2K	Resistor 4.7K
1	Zone No. 1	Zone No. 2
2	Zone No. 3	Zone No. 4
3	Zone No. 5	Zone No. 6
4	Zone No. 7	Zone No. 8

For testing eight zones mode connect resistors as shown in the drawing below, figure 2.3.

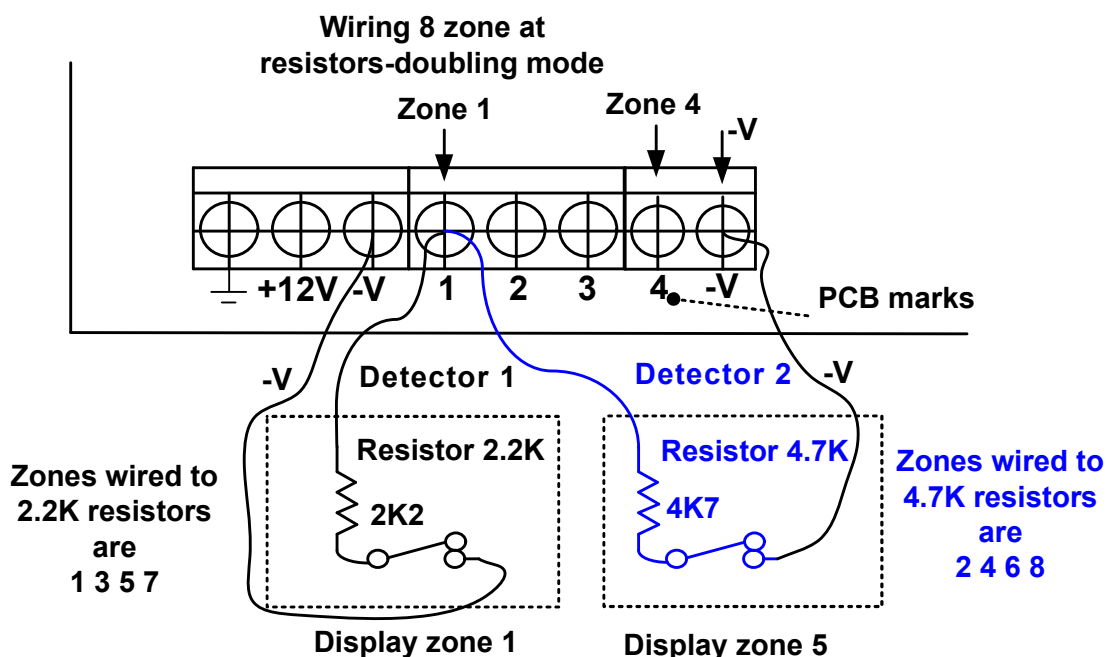

Figure 2.3: Resistors doubling mode zone wiring (in eight zone mode)

2.3 Keypad Wiring

Up to three AV-706 or AV-707 Keypads can be connected to AV-3004/48 Control Panel. When few keypads are connected, wire each one directly to the panel, not from one keypad to the other. Refer to drawing in next page.

When using few keypads connect them in parallel. Each keypad has four terminal wires:

- (+) Power, connect to + Aux. Power
- System Data, connect to OR
- (-) Power, connect to - Aux. Power
- System Strobe, connect to YE

Easy Tip

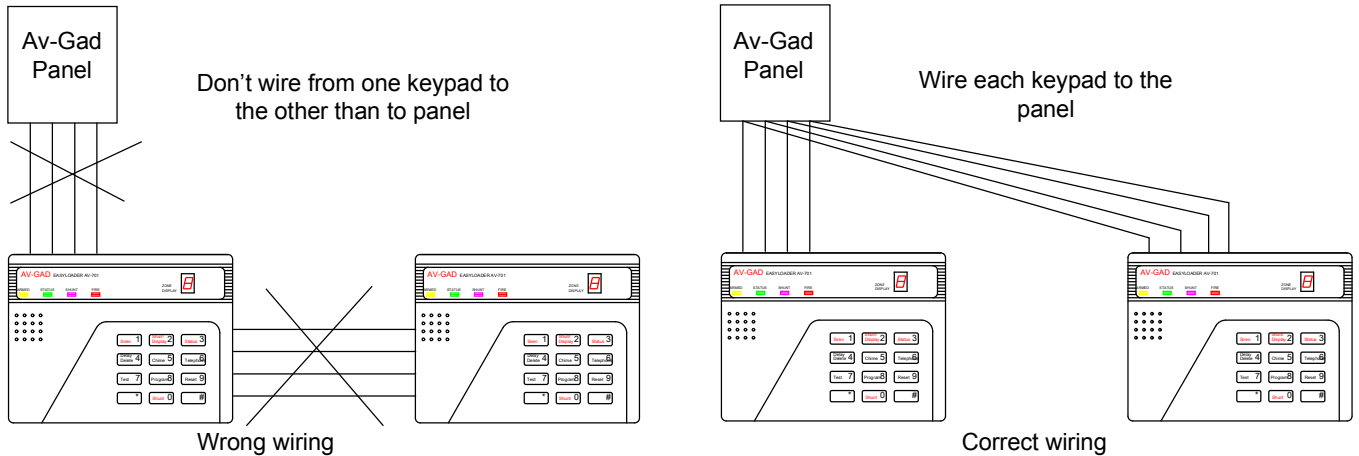

Figure 2.4: Wiring more than one keypad

Wire length for each Keypad should not exceed 100 meters (328.08 feet) (when using 0.5 mm² wires).

For longer than 100 meters keypad wiring, contact manufacturer's consultant. For AV-707TP (keypad with tamper) run five (5) wires. Connect the TMP terminal to a 24H or Tamper zone.

Power at Keypad should be a minimum of 11.5 Volts.

IMPORTANT! Never run Keypad wires alongside telephone wires, high voltage wires, or transmitting antennae. Wire the keypad wires separately and not in same cable with other devices (telephone, PIR etc.)

For proper connection, refer to wiring diagrams at the end of the manual.

Easy Tip

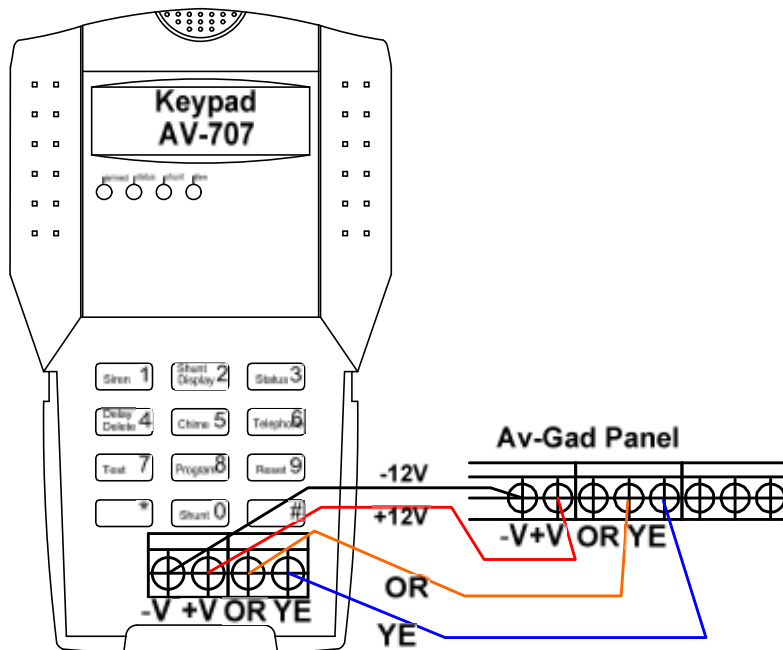

Figure 2.5: Wiring keypad to control panel

2.4 Siren Wiring

The control panel contains single siren outputs, protected by Electronic Fuse. Siren should be outdoor type with a 12V DC, 1A or optional (requires programming) speaker siren with minimum power of 15W, 8 Ohms Impedance. Enclose the siren in a metal housing, with anti-tamper switch protection.

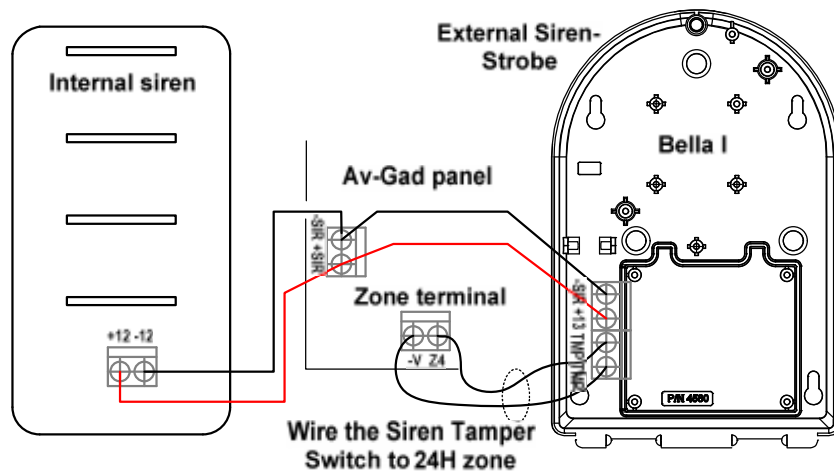

Figure 2.6: Wiring sirens to control panel

Warning, siren/s current should not exceed 1.0 Ampere

Bell mode is factory default; in Bell mode a 12V DC siren is required, such siren which contains sound driver or electronic module that operates on 12V.

The alarm issued by the siren differs according to the type of zone.

Bell Mode converts Siren outputs into 13.6V DC outputs (no sound is issued).

Bell mode is applicable for driving self-powered sirens or bells, or combined sirens and strobes.

13.6V DC is issued at Bell mode. It's recommended to use Bella sirens series.

In Bell mode, connect **only** sirens, which contain sound driver or electronic modules.

Self contain Bell mode is programmable (address 072-1 and 073-3). This mode provides connection of Bells or Sirens that requires 13.6V at idle and 0V during alarm. Contact manufacturer's consultant before connecting higher power loads.

To connect self-contained sirens, Bells, and inner-oscillating sirens, Bella siren series refer to address 072-1 for Bell mode. Bella sirens support internal battery charge and monitor for higher security.

For higher security it's recommended to have internal and external siren, see below drawing.

Siren configuration programming address

Address	Feature	Explanation
070-1	Siren beep upon arming	Sounds a short beep to indicate arming
072-1	Bell mode	Send 12V DC to drive the siren
073-3	Self contained siren	Send 12V at idle, drop to zero V at alarm
073-6	Siren 3 peeps at disarming	Sounds 3 short beeps to indicate disarming
063, 064, 065	Siren duration times	Configures the siren times

2.5 Remote Indication Terminals

Indication	Application
ON	(-V) on closing (Arming) or if cross-zoning feature selected
A1	(-V) during alarm from the programmed zone

The A1 may be used to drive a low current Strobe Light (Xenon) that consumes up to 300 mA.

Home Automation feature: Momentary activation of A1 output for three seconds, via any DTMF telephone command (address 074-2). See drawing sample.

In case other features are selected for the same output, this feature is not applicable.

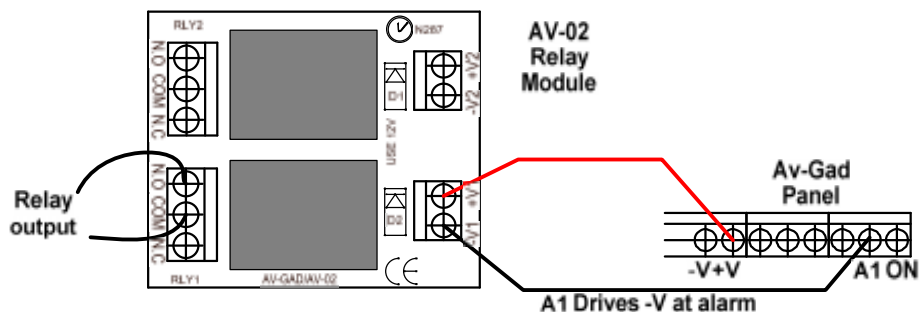

Figure 2.7: Wiring remote indication output to a relay

2.6 Remote Indications Testing

To test the remote indication outputs without entering to alarm mode; enter to programming mode (hold down 8, enter 1994, followed by #).

Testing ON output, enter 200 than 30 to enable, 200 than 31 to disable

Testing A1 output, enter 200 than 32 to enable, 200 than 33 to disable

To quit programming mode enter 999 than #.

2.7 Grounding Wiring & Lightning Protection

The control panel must be earth grounded for lightning protection to work effectively, and in order to prevent RFI and EMI interferences. Connect the ground to a verified cold-water pipe using a minimum 16 AWG (or larger) wire. Run the wire via the shortest possible route.

System grounding is compulsory

Note: Connect the Ground wire, to the \equiv terminal. This is not a minus (-V). Be careful of static discharge; before handling the main board touch a grounded metal surface to discharge.

Before grounding the system, make sure to connect ground properly, check that ground does not transfer high voltages.

2.8 Back-Up Battery

Make sure to connect the Battery in the correct polarity!

The system's Red wire is the positive pole (+) and the Black wire is the negative pole (-).

- The battery will provide power back up in case of AC power failure.
- Connect back-up battery to ensure proper operation of the system.
- Recommended battery: 7 Amperes per Hour (AH), 12V (sealed lead acid) type.
- A 7.2 AH battery backs up the control panel and a single keypad for approximately 8 hours.
- Series 3000 panels accommodates a battery of up to 12V – 7.2 AH (max.).
- An Electronic Fuse rated at 2.5A protects the battery.
- Add a power supply for installation with over three LCD keypad and/or if over ten high current sensors included. Refer to Av-Gad AV-21, AV-40 power supply and charger.

The 4AH–12V battery fits in the ABS box, but the door is too tight, why? Note the following:

- 1. Notice a small bulge on the ABS box door designed for supposing and holds the battery may displace the battery; place the battery near this bulge and not on it**
- 2. Make sure that the battery is not laying on the wiring**

3. TELEPHONE LINE AND CENTRAL STATION

3.1 Telephone Line & GSM Wiring

Dialing sequence: 1st dials to central stations, 2nd send SMS, 3rd dials to standard phones (wired or mobile). If central station not programmed sequence is bypass.

It's recommended to connect the control panel to an independent telephone line, if a device is connected in parallel with the alarm panel, this may grab the call first (like a message answer/fax) during remote up and download and remote DTMF. Don't connect fax or answering machine in parallel on the same telephone line.

Default dialing mode is DTMF. At areas with low quality PSTN Pulse Dial (old dialing format) is optional, at Pulse Dial mode the default is European Make/Break rate of 40/60 milliseconds (in Pulse dialing).

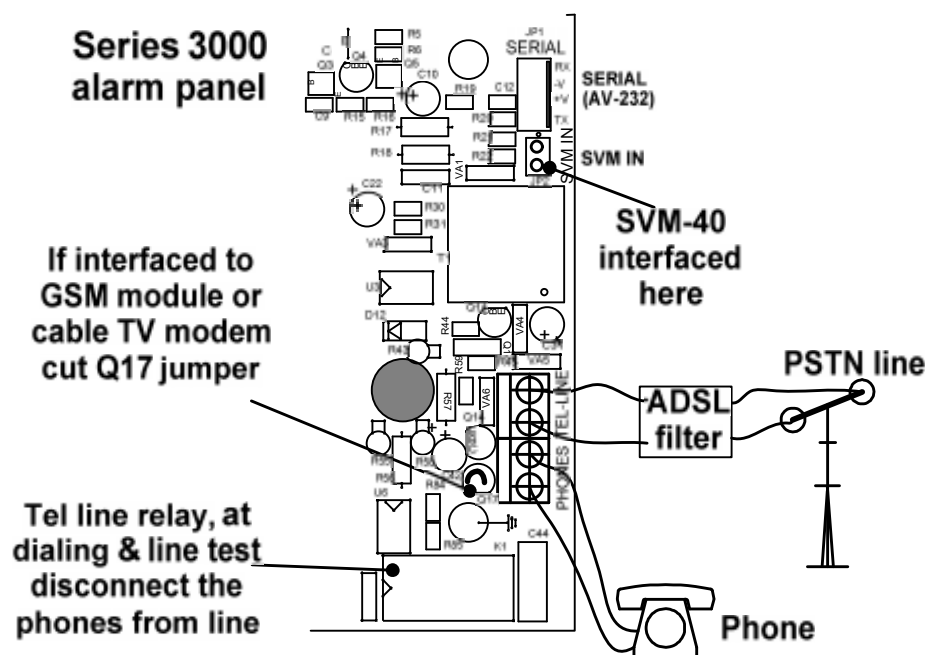

Figure 3.1: Wiring Telephone (PSTN) Line

Dialing mode is programmable (refer to programming sheet addresses 084).

Connect the telephone line to 'TEL-LINE' terminal, if handsets connected to same line connect them to 'PHONES', when system attempts to dial the 'PHONES' is disconnected.

Do not connect to ISDN or other digital telephone system. Most ISDN converters contain an Analog line; connect the Analog line of the ISDN to the panel TEL-LINE terminal.

If the PSTN is DSL/ADSL type connect a dedicated line filter supplied by local Telecom Company, or Av-Gad AV03 high end ADSL filter.

If GSM module is required: Use high end unit like AVG-14, AVG-15. Cut the jumper at the PCB, located at the right-lower side of the PCB, see drawing at wiring diagram.

Consider that low quality GSM module cause great problems like wrong dialing, RF interferences, wrong reporting to central station and disables the DTMF remote control feature.

3.2 SVM – Synthesized Voice Module

The SVM-40 Synthesized Voice Modules (SVM) is optional (not supplied with the panel). The SVM allows the recording and playback of two messages, with optional playback through an external speaker (not included) or via the phone during alarm.

SVM-40 message duration is 40 seconds. The SVM contains an on board microphone.

The SVM is a high technology device, electronically stores messages with or without power.

The SVM is as a digital message source in Series 3000 Alarm Control Panels, telephone dialers or in other applications. The SVM supplied audio is capable to drive audio amplifier, message center, automatic dialer or other device.

When connected to series 3000, program the SVM to be activated per zone, refer to the zone features section address 046, 047. At 046 the ON output will trig one channel of the SVM and on 047 the A1 output will trig the other channel of the SVM.

For setting the message length refer to address 053, 064, 055.

Follow the wiring procedures (included in SVM manual) simulate alarm; the panel will dial first the central station telephone numbers, then dial to other programmed numbers. After dialing, the panel will trig the SVM to send the recorded message.

3.3 Answering Machine Bypass

For remote up and download, and DTMF remote control you need to call up the alarm panel.

In case the alarm panel connected with fax or answering machine on the same telephone line (not recommended) enable the Answering Machine Bypass or Answer Now features (otherwise connection is impossible).

To enable the feature:

1. Program 7 at address 074
2. Program at least 24 seconds at address 096 (Ring Time Out)

To proceed: Dial to the control panel, count at least three rings and disconnect, dial again after 10 seconds – the panel will answer at first ring.

When Answering Machine Bypass enabled, the control panel will answer at first ring if:

- There was a pause of at least 10 seconds from last ring
- The panel already counted at least three rings before the pause
- Number of rings to answer (at address 091) is less than 20

Notice: The panel will answer (in a normal mode) if there is no pause and the rings counted exceed (or equal) the number programmed at 091.

3.4 Telephone Line Test

Series 3000 includes Telephone Line Monitor (test), refer to address 094: Time interval between telephone line tests - in hours. In case you need an external telephone monitor order item: TLS (Tele-Spy).

Range between 00-24. When '00' programmed no test performed. Failure to get a dial tone when dialing will cause a "Phone Line Fault" event.

3.5 Contact ID Format

AV-3044 PRO is able to send report for two separate central stations, address 017,018.

For Central Station (CS) reporting two telephone numbers are available, CS tel. 1 (address 017) CS Tel. 2 (address 018) for central station reporting.

Contact ID Format (known also as Ademco Express) is the fastest to program and easiest to use communicator format for central station, with communication speed achieved by the DTMF signaling.

When using Contact ID format, program only Central Station telephone numbers and the subscriber ID; all reports will be automatically transmitted, with no need to program anything else. To delete a tel. number: In programming, enter address (like 017), hold # & *.

Step by step:

1. Address 017, 018 enter the central station (CS) telephone numbers
2. Address 201, 202 program 07 (set by default)
3. Address 203, 204 values depends on the CS receiver, in most cases program 02 (High Low) this the factory default
4. Address 360, 364 program the subscriber number; the CS will provide the ID, keep 4 digits as the subscriber number.
5. Address 072 -3 determines the opening/closing report status

3.6 ID Codes for Communicator

Easy Programming is the most convenience way to add central station codes when Contact ID formats is used.

Note: Even if your communicator receiver requires three digits for the subscriber ID, enter four digits. The system will ignore the fourth digit automatically. Example user ID is 123 enter 0123

If the central station requires letters as well as numbers programming, please refer to the HEX programming description. Use the regular programming method of entering each letter or number in each address, as explained in the programming table (HEX method).

Note: EASY Programming is not included in the *EasyLoad* screen (programming via computer).

3.7 Remote Up and Download

EasyLoad Introduction

The remote up and download feature enables fast and simple programming of EasyLoader panels. Programming tables, codes and other features may be up & downloaded from an on-site PC (DOS or Windows Mode) via telephone using Modem and 'EasyLoad' software, which is supplied separately. The control panel contains a full-duplex modem that conforms to BELL 103 standard.

Installing EasyLoad on your Computer

The installation program will guide you, and will install EasyLoad automatically by making a new directory called AVGAD, or one of your choices. The README 1st file supplied with EasyLoad will help you operate the up and download program.

DOS old version: To start your EasyLoad: At the prompter 'C:\AVGAD' type 'ESAV'; you will be notified that some files are missing (the database). Answer 'Yes' to create them.

The main EasyLoad menu contains seven selectable fields, to enter main menus use the arrows (right part of computer keypad) or by entering the field number. Using a mouse is highly recommended.

Easy Tip

The control panel modem is set by default to answer the PC after 10 rings - see address 091, change address 091 to or higher (21 to 99 rings) in order to disable panel modem. Hold down key 6 then hold-down key 1 for 'Answer Now' mode.

Configuring your Modem

First, verify that your modem is Bell 103, refer to manufacture data sheet.

Configure your modem port using the SET-UP entry from the main menu (field 7). Specify the COM PORT, on which your modem is installed, making sure your mouse is not on the same COM PORT. Do not use COM1 and COM3 or COM2 and COM4 simultaneously. If you cannot initialize modem, use the Auto Detect option. Av-Gad supplies the proper mode, and inverter for USB computers.

The PC keyboard can also be used, e.g. Move from field to field using arrows (when possible), the TAB key (forward), shift + TAB (backward), ALT key + highlighted letter. Confirm input in text fields by hitting the ENTER (return) key. In order to select the required field; hit the highlighted digit or letter.

Full instructions and latest features are enclosed in the EasyLoad software diskette.

Local Up and Download via PC (AV-232 required)

Series 3000 alarm panels provides local up and download via RS-232 or modem.

When using the AV-232 interface (special RS-232 cable and interface connecting the PC to the panel) set the panel to programming mode; type 77 at address 200 (i.e. type 200 than 77) before attempting to establish connection.

When using the AV-232 cable the transfer rate is 8 times faster than through the modem. With local PC, use the same procedures as described below. Maximum AV-232 length is five meters. If your computer is using USB as serial interface order the RS-232 to USB adapter, item AVUSB232.

4. REMOTE DTMF AND REMOTE ARMING

4.1 Remote Key and Wireless Arming & Disarming

The AV-3004/48 enables Arming and Disarming by remote momentary or latch key-switch (as programmed in address 071-7), which is connected to JP1 'KEY' and '- Aux. Power (Refer to Wiring Diagram). Order separately the cable set for connecting to JP1.

When using remote key-switch, wire length should not exceed 10 meters.

A Momentary pulse (momentary trig) between 'KEY' terminals will Arm and Disarm the control panel (close the 'instant' and '24H' zones Prior to arming.)

System reverts to previous status with next momentary pulse. (Refer to Wiring Diagram.)

For Arming/Disarming via Wireless Radio Remote, connect receiver's relay to 'KE' and '- Aux. Power' terminals. Verify the receiver relay mode, momentary, or latch, and set system accordingly.

For fast Remote Key wiring use a fast-insert connection, a dedicated wired connector is available (not included in the standard pack, order it separately).

In most cases the Key connector is applicable for emergency Disarming – Short the key terminal with screwdriver. For remote arming with wireless remote transmitter use the AVS22 RF set remote.

Zone 4 or 8 ("last" zone) may function (requires programming) as auxiliary remote key input, programmable at address 050-3.

The Aux. key Arms without Home (group) mode, sounds siren beep when arming (if programmed), sounds siren beeps when Disarming (if programmed).

4.2 Remote Access via DTMF

General Description

Verify that your PSTN line is supporting DTMF dialing, other important issue is that line is at good condition. Adding GSM module or low quality ADSL filter may interfere the DTMF commands.

DTMF commands are available when the panel call your phone, or by calling the panel. The DTMF remote control functions:

- Check the status of the control panel (Armed/Disarm, Alarm in progress)
- Arm or disarm the control panel
- Bypass zones or clear all bypassed zones
- Stop the dialer report during alarm
- Momentary activate A1 (alarm) output for three seconds
- First Alarm indication - by a number of beeps per zone, special tune for Panic alarm

The same options are available when a call is received from the control panel during an alarm condition.

To enable the DTMF control; Program address 074-6 "Enable remote access by telephone", and 074 - 2 "Enable A1 activation by telephone".

Keypad online confirmation and DTMF functions history

When the control panel detects the first DTMF key, five short beeps sound at the keypads. The keypad activation shows the user at the remote site that a DTMF connection takes place (in case of mistaken connection or similar).

During the remote access the keypad display DTMF status and all LEDs blink fast from time to time.

When the call ends, the three short beeps sound at the keypads. When the user code is in process, the keypad display shows a line for each code number entry (disclose the code), then each DTMF number pressed show the received number.

History log: Each call, confirmed by a valid user code, is recorded in the events history. Each "Arming/Disarming" is recorded in the events history.

Notes: 1. The keypad buzzer or other loud sounds may jam your DTMF entries, in case the keypad is close to your DTMF telephone, during testing disable the buzzer.

2. When entering the DTMF commands wait for "quit" period, if entering commands during the system confirmation tunes, or other tunes the panel may miss the DTMF entries.

The panel calls the user during alarm

When the control panel calls the user during alarm, it will first generate the siren sound for about 30 seconds (to shorten this feature at address 085 "Tel. Message Time", to 30, as default is 50 seconds).

The siren sound will stop ten (10) seconds before the end of the call and a greeting tune will be sounded, after the greeting tune enter your code followed by #.

To stop the dialer enter 6#, to get panel status enter 7#, to disarm the panel enter 2#. Press 9# to end the process.

The control panel will answer the call after the number of rings programmed at address 091 (or following the "bypass answering machine" procedure).

4.3 DTMF Commands

Each command must be followed by the '#' key (Enter) in the remote phone. The control panel waits 4 seconds between the keys typed. When this time expires, previous keys input will be discarded.

The key '*' cancels previous input. It's recommended to start with "learn" function [8X #] to identify the various confirmation tune.

The commands:

[0 X #] - **Bypass zone** (# is the Enter key)

X is Bypassed zone 1 to 8

To clear all bypassed zone: 0 9 #

The zone bypass command is valid only when the system is in Disarm position and not in Alarm position.

[1 #] - **Arm control panel**. The control panel will be armed even with open zones. After the arming, a confirmation tune followed by an "armed" tune will be sounded ("Armed" tune: Short beep followed by a long tone.).

The user can wait a few seconds to be sure that no alarm has been caused by open zones. In this case, an Alarm tune (siren sound) will be sounded.

[2 #] - **Disarm control panel**. The control panel will be disarmed. A confirmation tune followed by a "disarmed" tune will be sounded ("Disarmed" tune: Five short beeps).

[31 #] - **Activates A1** output for 3 seconds (enabled by programming 074-2)

[6 #] - **Stop dialer**. The dialer will stop calling the programmed telephone numbers. This will affect only the current dialing process. A new alarm will re-start the dialer.

Note that if the user answered a call from the panel or called the panel during a dialing period without Arming/Disarming/Stopping the dialer, the dialer will restart the cycle from the beginning.

[7 #] - **Check control panel status**. The control panel will answer with an Armed or Disarmed tune followed by an Alarm tune if it is in an alarm condition.

[7 and 7 #] - **First Alarm zone**, beeps count for the zone number. Report to user the zone that caused alarm. Arming or Disarming clears the First alarm zone reported by DTMF.

[8X #] - **Learn function**. Using this command, the user can become familiar with the various sounds used by the control panel in the remote access procedure. Further details find in the dedicated paragraph. (X - The required sound).

[9 #] - **End call**. The control panel will sound a confirmation tune and will hang up.

5. SYSTEM CODES

5.1 Description of main codes

Up to eight (8) different Arm/Disarm codes and one installer (dealer, programming) code are available; each code consists of 1 to 6 digits.

Do not use '0' as the first digit in a code.

Do not use '5' as first digit in a code number if *Instant Arming via key 5* was programmed.

User code must not start with the same numbers as the installer programming code (1994).

Do not use same codes or same first 3 digits for different codes. For example if user code No. 1 is 123, other user code cannot be 1234.

1. **Default Arming and Disarming Code '1 2 3 4'** (Code No. 1) - Use '1234' as Arming Code (also called Owner Code). Use code No. 1 to program a new user code. Upon setting new Arming & Disarming code, default user code '1234' automatically replaced.
2. **Code number 7 for access control** (requires programming) - Arm/Disarm code No. 7 activates the SLO (Selective Output) output, which is used for such functions as opening an electric lock. Code number seven (7) is operative during ARM and DISARMS modes, confirmed by seven short beeps. Code 7 drives the SLO output as 'Momentary' output. Pulse duration is 5 seconds.
3. **Code number 8 as Visitor Code** (requires programming) - Arm/Disarm code Number eight (8) is for 'one time code' (employees and one-time visitors). This code is valid for 30 seconds from Arming. After 30 seconds, the code is rendered as invalid. Entering code 8 will delete zone bypasses, including auto-bypass.
4. **Change Programming/Installer Code.** In installer programming mode, at address 099 enter the programming code you require. The factory default programming code is '1 9 9 4.' The programming code may be installer-programmed. Installer code does not Arm or Disarm system. See 5.3 for setting new programming code.
5. **User Codes** - (Arming and Disarming code). Each code consists of 1 to 6 digits. System provides eight user programmable codes.
6. **Key Visual Feedback** - Visual 'feedback' from the keypad display upon entering of code. This feature indicates the code entry progress and is most practical when the keypad buzzer is disabled at Group Bypass mode, or if selected by programming. Code entry by user or installer is confirmed at keypad display. Display segments will light up clockwise, indicating the sequence of the digits entered.

Typing six erroneous codes will lock the keypad keys for 30 seconds

5.2 Set New User Code

1. Hold down key 
2. While the four LEDs are blinking, enter code No. 1 (default 1 2 3 4)
3. If code is valid, "User Programming" displayed
4. The 2 left-most LEDs blink to indicate that the system is waiting for a new user code index (user 01 to 08) to be entered



User Programming

5. Enter the code index from 01 to 08 (01 for code No. 1; 02 for code No. 2, etc.)
6. The 3 right-most LEDs blink to indicate that the system is waiting for a new code (from 1 to 6 digits) to be entered.
7. Enter the new code than #; new code and user index is displayed for confirmation. If during 60 seconds data not entered system automatically escape from code setting.
8. To quit code setting press '99' than #.

5.3 Installer Programming mode & Code change

1. Hold down key , while the four LEDs are blinking, enter 1994 (default code) followed by #. "Installer Progr." displayed, 2 left-most LEDs blinking.
2. While system is in installer program mode
3. Enter 099, than the new code than #
4. New code displayed for conformation. System reverts to Installer Programming mode.
5. Enter 999 than # to exit

5.4 Delete a User Code

1. Hold down key 
2. While four LEDs are blinking, enter code No. 1 (default 1 2 3 4)
3. To erase an existing code: Enter user index number (02, 03, 04..not 01), Hold Down simultaneously the '*' and '#' keys, followed by #, E (erased) will be displayed. The Master (code number 01) cannot be erased.

Instant Arming by key number  is a programmable feature, which may cause erroneous Arming. It is recommended to *disable this feature*. Do not to use 5 or 0 as the 1st digit of the code

5.5 Auto Arming

Programming the time for Automatic Arming: Requires entering to User Programming mode.

To set systems clock when Auto Arming enabled: Press 20 and enter the time in 24H format, confirm with #. Press 20 and # to display the system clock.

To set Auto Arming Time: Press 21 and enter the time in 24H format, confirm with #. Press 21 and # to display the Auto Arming time.

If Automatic Arming is programmed, the system time can be set only via User Programming Mode: Enter User Programming Mode (hold-down 8 and 1234), hold down '1' ('t' is displayed) and type hour and minutes.

Hold down key '1' and wait for the time display. Holding down keys '0' then '1' (in use mode) to program the time is possible only if the Automatic Arming is disabled (otherwise an 'Error' warning is displayed). Those settings procedure at PRO and Dublo panels are different; refer to the AV-706/7 keypad manual.

Automatic Arming will not operate if the system time has not been set (blinking 'h'). Automatic Arming will not operate if the control panel is already armed.

Automatic Arming will operate even if the control panel is currently in alarm.

When the Automatic Arming programmed time arrives, the system starts at a 30-second countdown. An 'A' is intermittently displayed and beeps are sounded at the keypad.

During the countdown period, to abort Automatic Arming enter a valid user code (not code No. 7, if used to 'open' a door).

5.6 Restore default codes

Restore default codes feature requires programming at 072-8 (programmed by default). Disabling the feature prevents codes restore.

To restore the factory default codes; Power down then Power up by applying AC, immediately (during 20 seconds) hold-down keys Press both together after 2nd beep, release keys, to confirm *** OK *** is displayed on LCD.

After proceed the restore: User code = 1234, installer code =1994, all other codes removed.

To set codes to default during programming; in address, 200 enter 05, all codes will restore to default.

6. LCD KEYPAD

For full description of the LCD keypad installation, text editing and more details refer to the keypad manual.

6.1 Hold-Down Functions

- Holding down the key for approximately 2 seconds accesses hold-down functions
- Hold down functions are confirmed by a long beep

Hold-Down Functions:

Key 1 → **SIREN TEST**

Key 2 → **SHUNT DISPLAY**
Displays shunted zone(s).

Key 3 → **STATUS DISPLAY**
Displays troubled or malfunctioning zone(s).

Key 4 → **DELAY DELETE (INSTANT PROTECTION)**
Cancels Entry delays in zones selected as 'Delayed' zones. All zones become Instant. Delay Delete is displayed in confirmation. Instant Protection becomes effective only if System is Armed within 20 seconds following hold-down of key 4.

Key 5 → **DOOR CHIME**
Enables Chime when opening zone. Door Chime operates on Chime-programmed zones. Hold-down key 5 enables and disables the function.
Chime mode is confirmed by 'c' display on keypad.

Telephone 6

Key 6 → DIALER TEST & FOLLOW-ME PROGRAMMING

Test is performed in 'DISARMED' mode.

Function	Via AV-70X LCD Series Keypad
Displays Programmed Follow Me Telephone Number Without Dialing	Hold-down key [6]
Follow Me telephone number programming	Hold-down key [6] then hold-down [6] again
Programmed Telephone number Verification (Display and Dial 4 telephone numbers)	Hold-down [6] then hold-down [7], number not displayed

Display programmed telephone numbers without dialing: Within few seconds, text will appear on the display, followed by the (programmed) 'Follow Me' telephone number.

When programming telephone numbers which require an inter-digit delay ('Pause') during dialing; Hold-Down key [0], a momentary Pause will be displayed (Delay duration is 3 seconds).

The 'Follow-Me' number will be displayed, or displayed and dialed, followed by display-and-dial of up to three additional telephone numbers.

Telephone 6

and

Siren 1

Address 092 enables 'Answer now' feature, the system answers remote computer after one ring. This feature is important if the control panel programmed not to answer incoming calls (programming of 21 rings or greater at address 091). To enable 'Answer Now' feature program 01 at address 092.

Hold-down key 6 and then key 1, before the computer and modem connect (dial) the control panel. The panel will acknowledge the command with two beeps and display an 'A.' The feature remains active for 5 minutes after entered, enabling to remotely program (from remote computer) the panel.

Other possibility to connect to a system connected on same line with a fax or answering machine is to use the "Answer machine bypass" feature.

Test 7

Key 7 → FAULT FIND

- Fault Find enables testing of all detection devices.
- Fault Find mode is accessible only during 15 seconds following System Disarm.
- 24H, Fire or Panic alarm will stop Fault Find mode.
- Hold down key 7.
- Open and close each zone to test the zone regularity. A one-second beep confirms detection of zone opening. Three beeps indicate zone closing.
- Quit Fault Find mode by Arming the system.

Program 8

Key 8 → PROGRAM

Key 8 accesses 'Program' mode and user code programming (followed by password)

Reset 9

Key 9 → RESET. 'Reset' performs the following functions:

1. Cancels last Keypad entry

2. Stops the communication test (triggered by hold-down key 6)
3. Activates output 2 for resetting the Smoke Detector (requires programming)
4. Resets Day Zone Alarm at Keypad
5. Exits Programming mode (features, telephone numbers, etc.).
To exit programming mode enter 999 than #



6.2 Group Bypass (home mode)

Group Bypass operates in few ways, commands:

- 0 & hold-down key 1 - Arm with group 1 bypass, or 0+0 - Group 1 Bypass
- 0 & hold-down key 2 - Arm with group 2 bypass, or 0+0+0 - Group 2 Bypass
- 0 & hold-down key 0 - Arm with group 1+2 bypass, or 0+88 - Group 1+2 Bypass

Each command works as a toggle SET/CLEAR.

The AV-707B provides arming and group bypass by pressing one key (refer to keypad manual).

 and . Press key '0' twice for Group Bypass. Operative only if system is Armed within 20 seconds after entry of this feature. Yellow LED will flash; 'h' (Home) will be displayed for 1 second in confirmation.



To activate Group Bypass II press key '0' three times. To activate both group bypass groups, press 0 then 88.

When Group Bypass is selected, the buzzer and LEDs react as follows:

- The Shunt LED stops blinking 8 seconds after Arming, (prevents LED light from disturbing sleepers near the keypad)
- There is no exit/entry delay-warning buzzer, and keys beep at the keypad.
- There are no 'beeps' at the keypad until an alarm occurs, or until Group Bypass is canceled.
- When the keypads LEDs are turned off after Arming (requires programming), touching the keypad will turn them on for 5 seconds.

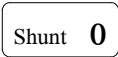
6.3 Key Zero Hold-Down functions

1.  Key 0 **Concise Alarm History**: Hold down key '0' to display the last alarm sequence.

2.  and  **Detailed Events History (requires programming)**: Hold down key '0' and again hold down key '0' to display up to 36 events, including: System opening and closing by user number, opening or closing time, alarming zone and AC fail. By holding-down key  twice, 3 LEDs start blinking, to indicate a special operation mode. The events are displayed from the most recent event to the oldest.

3. To silent local keypad buzzer hold down key "0" and #, to activate the buzzer repeat the 0 and #.

Event	AV-707, 706 display
Time set	xx Time Set
Date set	xx Date Set
Installer programming	xx Installer Prg
User programming	xx User Program
Factory defaults	xx Fctry. Default
Communication (to CS) failure	xx Comm. Failure
Panic from Panic zone	xx PANIC
Keypad locked (code error)	xx Keypad Locked
Low Battery	xx Low Battery

Table 1: Events as displayed at series 3000

6.4 LCD Dual Keys Functions

1 st key hold down	2 nd key hold down	Function	Note
Shunt 0	Shunt 0	Display alarm and events history	Press # for next, hold down 2 for previous event
Shunt 0	Siren 1	Set system clock in 24H format	Like 23:10
Shunt 0	Shunt Display 2	Set system date	DD-MM-YY. Like 01-02-12
Shunt 0	Delay Delete 4	Display last alarmed zones	
Shunt 0	None	Display last alarm	One alarm only
Telephone 6	Delay Delete 4	Send events history by SMS	
Telephone 6	Chime 5	Test SMS reporting	
Telephone 6	Telephone 6	Program the Follow Me telephone. Tel 1, location 013	
Telephone 6	Test 7	Test dialer	
Telephone 6	Program 8	Test communicator (reporting to central station)	

6.5 Keypad Functions at location 200

Default means “Factory default”.

In programming mode enter 200, than the required function as detailed below.

Location	Function
200 and #	Display control panel type & software version
200 and 04 and #	Erase (reset) the events history
200 and 05 and #	Restore all codes to factory default
200 and 69 and #	Restore program to default
200 and 70 and #	Restore zone and logo default texts
200 and 71 and #	Download all texts from panel to keypad

200 and 72 and #	Download zone description & logo only
200 and 77 and #	Set panel to PC Communicate Mode
200 and 78 and #	Arm panel from programming mode
200 and 44 and #	Set panel to four (4) zones Mode
200 and 48 and #	Set panel to eight (8) zones Mode

Browsing through Events History

When starting History Events mode the events are displayed from beginning to end without any break, until any browsing key is pressed.

During History Events, browsing system will respond only to alarm or panic, Arming denied. Alarm or Panic during History Event mode will quit this mode and system will set to Use Mode (normal operation mode).

For easier detailed alarm history, use the downloaded from panel to remote computer. History queue log of up to 250 events are displayed at panel keypad and in the *EasyLoad* PC software.

4. Shunt 0 and Siren 1 **Display and Setting of System Time:** Hold down key '0' and then hold-down key '1,' 3 LEDs will blink. Wait for the display of system time in 4-digit format.

To set new time, hold down key '0' and then hold down key '1.' Do not wait for time display; enter the new time in 24-hour format. The local clock time is not stored in system memory; clock must be adjusted after power-up. After powering-up system, time is reset to 00:00, 'h' will be displayed to remind user to set time; 'h' will disappear after setting the time. If Auto-Arming enabled the clock setting is form user Programming mode only, refer to Auto-Arming section.

For clock setting during winter/summer time changes (set by end user):

Hold down key "0" press key "1" than again 1 - increases hours by one

Hold down key "0" press key "1" than key "0" - decreases hours by one

5. Shunt 0 and Shunt Display 2 **Display and Setting of System Date:** Hold down key '0' and then hold-down key '2'; 3 LEDs will blink. Enter date: 'dd mm yy.' The up and download PC software displays time and date, along with event history.

The local date is stored in system memory; adjust date after long power-fail.

Years 00 through 77 translated as 2000 to 2077

6. Shunt 0 and Status 3 **Concise History of Tampered Zones:** Hold down key '0' and then hold down key '3' to display the Tampered zone alarm sequence.

New alarm will create a new history event instead of old one.

7. Shunt 0 and Delay Delete 4 **Reset Events Memory (history):** Not available.

Instead, during the installer-programming mode, clear history by command 200+04.

8. Shunt 0 and Chime 5 **Display Last 2 Users:** Hold down key '0' and then hold down key 5 to display user number and System opening or closing time.

'o' is displayed for Opening (Disarming); 'c' is displayed for Closing (Arming).

9. Press (not hold-down) and press (not hold-down), will display '-' to cancel all Bypassed Zones.

Keypad Panic Keys → **PANIC BUTTON**

Holding down * and # keys will trigger Panic alarm. H will be displayed (zone 'H').

To cancel *Hold-Down* function accessed by keys [0], [6] and [7]; Hold-Down key 9 (Reset). To quit zero hold-down functions, hold-down '9'

6.6 Keypad Sounder

The Keypad sounder (buzzer) enhances the use of system operation and serves as a local alarm device (requires programming).

The sounder emits sounds in the following instances:

OPERATION	SOUNDER RESPONSE
◆ Pressing of any key	Short confirmation beep
◆ Power up	Six beeps
◆ Hold-down functions	Long confirmation beep
◆ Faulty programming input	Long beep (+ 'E' display)
◆ Delayed Zone triggering	Three long beeps
◆ Exit delay starting (if programmed)	Warning beeps until the delay is over
◆ Completion of Arm/Disarm programming code	One long confirmation beep
◆ Programming Telephone numbers	Two confirmation beeps
◆ Completion of address programming	Two confirmation beeps
◆ Pressing 'Code 7' for driving door opening	Seven confirmation beeps
◆ Arming of System with Instant, Fire or 24H troubled zones	Five warning beeps + troubled zone display
◆ Feature programming	Two confirmation beeps
◆ Follow-Me number programming	Two confirmation beeps
◆ During alarm (requires programming)	Intermittent beep until alarm reset

The each keypad buzzer can be turned ON/OFF by holding down keys "0" and "#" simultaneously. When the buzzer is ON, it will sound while the keys "0" and "#" are being held down. When the buzzer is OFF, hold down the keys for 2-3 seconds, sounder feedback heard in this case only after releasing the keys.

The buzzer set ON at "Power On" and every time the keypad is in programming mode.

6.7 LED Indicators

AV-705, AV-706 and AV-707 Keypads: Four LEDs provide visual indication of System status, as well as confirmation of various modes.

Keypad LED's indication

Armed LED-Red	Series 3000
Off	System Disarmed
Blink slowly	An alarm is triggered
ON steady	System Armed
Blink fast	Mode does not exist

Status LED-Green	Series 3000
Off	System Disarmed
Blink slowly	Some zones are open
ON steady	All zones OK
Blink fast	Some zones have been tampered

Shunt LED-Orange	Series 3000
ON steady	Some zones are bypassed
Blink slowly	Group bypass entered
Blink slowly	8 seconds after Armed with Group Bypass

Fire LED-Red	Series 3000
Blink slow	Warning before Fire alarm
Blink fast	During and after Fire alarm

Note: At alarm time Troubled Zones are displayed at the Keypad.

○ **Red ARMED/ALARM Indicator** - Lights up when system is armed, and blinks after an alarm is triggered at any zone. Blinking indicates alarm history in memory.

○ **Green STATUS Indicator** - Blinks when zone/s are troubled and remains lit as long as zones are clear, rapid blinking during Tamper alarm.

○ **Yellow SHUNT (Bypass) Indicator** - Lights up upon zone bypass.
(Note: may light automatically upon arming if Auto Bypass was programmed).
The indicator also lights up and blinks if a Group Bypass was entered by pressing '0' twice.

○ **Red FIRE (Trouble) Indicator** - Rapid blinking when a Fire Zone is troubled.

○○ **Two LEDs Flashing (Left Most LEDs)** - In user code programming mode, rapid blinking indicates code or code index to be entered. In Installer programming mode, it indicates address entry.

In Disarmed mode, the two left-most LEDs blinking + zone number display indicate 24H-alarm mode.

○○○ **Three LEDs Flashing** - In Disarmed mode, rapid blinking indicates AC power failure. AC power fail event is displayed in Events. In Armed mode, rapid blinking indicates system restored after AC Power Failure mode.

During programming Follow-Me Telephone Number, three flashing LEDs indicate to enter a new telephone number.

○○○○ **Four LEDs Flashing** - Upon holding-down key '8,' the system is ready for code to be entered. (Same LED indication when code is expected for Bypass via code).

7. NEW ADDRESS AT SERIES 3000

7.1 Systems parameters address

System parameters 072

Modification: 072-5 Enable bypassed zones reporting at ARM - The parameter is enabled by default.

System parameters 075

Enable Sounds in HOME mode - 075 - 1
New connection order enabled - 075 - 2
Enable Double report to Central station - 075 - 3
Enable Slow Response (for "Fast zones") - 075 - 4
Enable – Open/Close report by SMS 075 – 5
Enable Listen-in using ALR1 via DTMF - 075 - 6
Enable ON/OFF strobe via ON output - 075 - 7
Enable ALR1 Latching- 075 - 8



EasyLoad: Series 3000 remote modem is not enabled by factory default (security reason). Check address "Enable PC connection/Download via modem" 076 - 1.

System parameters 076

Enable PC connection/Download via modem" - 076 - 1
Enable DISARM via DTMF remote command " - 076 - 2
Enable zones bypass by remote DTMF/PC " - 076 - 3
Enable date/time setting by remote PC " - 076 - 4
Enable SMS reporting- 076 - 5 set by default
Parameters 6, 7 see at programming table

Enable PC connection/Download via modem" - 076 - 1 (default not enabled)

To access the panel via remote PC this parameter must be set. The panel will not accept a connection from a remote PC when it is ARMED or there was an alarm.

When the panel is disarmed, a connection is always possible if the user entered the Answer Now command ("6"+"1"). Using the PC connection one can only ARM the panel, but not disarm it.

It is not possible to cancel the ARM command.

When arming, the user can bypass some zones or set the Home mode. Zones bypassing is possible only if enabled at 076 - 3.

Enable DISARM via DTMF remote command - 076 - 2 (default not enabled). The panel can be accessed via telephone using DTMF commands when Armed or Disarmed (if DTMF enabled at 074 - 6).

The user can disarm the panel using DTMF command only if the option is enabled at 076 - 2.

Enable zones bypass by remote DTMF/PC- 076 - 3 (default not enabled). Zones can be bypassed by remote telephone or PC only if this option is enabled.

Disable date/time setting by remote PC - 076 - 4 (default not enabled - meaning that the PC will SET the panel time and date t each connection). Setting this option will prevent the remote PC to modify and set panel's date and time.

Enable SMS events reporting - 076 - 4 (default enabled).

The panel will report if this parameter is enabled and a valid SMSC telephone number and one or two destination telephone numbers have been programmed.

7.2 Telephone and SMS address

Addresses modified:

Communicator Test Hour and minutes 004 def 00:01

Auto Arming Hour and minutes 006 def 00:00

Telephone numbers

There are 11 telephone numbers, 16 digits each.

No limitation on the numbers of pauses in a telephone number. The programmable digits are: 0,1,2,3,4,5,6,7,8,9,*,#.

Telephone numbers addresses:

008 SMS Service Center – To this number the panel send the SMS data. In each country the number is different call your PSTN telephone line to find the number.

009 SMS Destination number #1 (used to report events)

010 SMS Destination number #2 (used to report events)

011 SMS Destination number #3 (used to report events)

012 SMS Destination number #4 (used to report events)

(The Destination numbers are not dialed by the panel - they are included in the SMS)

013 Regular Telephone number plus follow me option #1

014 Regular Telephone number #2

015 Regular Telephone number #3

016 Regular Telephone number #4

017 Central Station number #1

018 Central Station number #2

Short Message Service via land telephone line (PSTN)

The panel sends Short Messages (SMS) via the land telephone line. The SMS service must be enabled on the outgoing telephone line connected to the panel. To enable the SMS reporting for the panel the installer must program:

- The SMS Service Center (SMSC) telephone number for Outgoing Messages (in some countries there are two telephone numbers, one for Outgoing messages and one for Incoming messages; in Israel for example the Outgoing telephone number is 14974800 and it is programmed automatically when returning to factory defaults). If required add the "external line access" code.

- One or two Destination telephone numbers. Those numbers will receive the messages sent by the panel. Each number must be programmed "as is" (without "access code") - those numbers are not dialed by the panel - they are part of the SMS message.

- Enable the SMS reporting the installer will program 076 - 5 (set as a factory default).

7.3 Events reported by the SMS module

SMS Test reporting

Zone event Burglary Zone number and description (**zone alarm restore not included**)
24 hour zone number and description
Entry/exit Zone number and description
Fire Zone number and description
Panic Zone number and description
Tamper Zone number and description

Disarm (Open) - by User number
- Via DTMF User number
- Duress (ambush) User number
- Via PC remote
- By Key

Arm (Close) - by User number
- Via DTMF User number
- Auto arming by timer-
- Via PC remote -
- By Key

AC Power - Failure
- Restore

Battery - Low Battery -
- Restore -

Emergency - Panic
- Medical
- Fire

PC remote Access

Communication to Central Station Failure
Each event is time/date stamped.
To test the SMS reporting: press/hold "6"+"5"

More features

* Reporting PC remote access to the CENTRAL station

If the panel was accessed by a remote PC (via the telephone line) then reports will be sent to the Central station (using CID format only):

- Successful access/download: code 412, user 99
- Arm /Disarm by remote: code 407, user 99.

* PC connection is always recorded in the History log

* If the PC uploaded programming data to the panel then the history log will show the following events:

xx PC Download Program table

xx PC Download

Telephone numbers

xx PC Download
User Codes

xx PC Download
Zones texts

* When the entry delay starts (by opening a delayed zone), the panel begins to dial to the regular telephone numbers. In this case, the panel sends a siren sound via the telephone. If an alarm condition starts (the panel was not disarmed), the panel will start the normal reporting cycle:

Report to the Central Station, SMS reports and, finally, alarm reports using siren sound and SVM recorded messages to the regular telephone numbers.

* Central Station test by "6"+"8"

If no telephone/ CS installed, dial test and CS test will give a function error.

* Activation of ON/OFF strobe via the ON output. Programmed at 075-7.

Arming: 2s ON, 1s OFF, 2s ON, 1s OFF, 2s ON, OFF

Disarming: 3s ON, 2s OFF, 3s ON, OFF

* Keypad warning from zones or troubles are "silenced" for 15 seconds after an enter or a password.

* Alarms only history display - called by "0" + "4"

* Listen-in function in DTMF mode, using A1 output:

5 + 1 Start

5 + 0 Stop

* A1 output "Latching" - A1 can be set for an unlimited time. To set the feature program "Enable A1 Latching" at 075-8

* A1 can be set (ON) by DTMF command 3+1 and reset (OFF) by DTMF command 4+1
If A1 was set - Latched by the DTMF command then it can be reset by "9" in disarmed mode, DTMF command 4+1. Normal System Reset (as when arming / disarming) will not release it.

- Each zone can be programmed to trigger Siren/SVM1/SVM2 alerts to four telephone numbers.

- Siren, SVM1 and SVM2 telephone alert times can be programmed.

- The panel can report to both Central Stations (double report) and only once to the Central Station that is available (one of the Central Station is in this case used as backup in case of failure to contact the other one).

Program Double report to CS at 075 - 3

- Central Stations can be programmed to report in different formats, each one using its own Subscriber ID.

- The communicator to central station has priority over SMS_reporting and the dialing of Siren/SVM alerts. The communication process will stop the alerts dialing. When it completes, the alerts dialing is resumed from the first telephone number for a complete number of repetitions.

Note that if the dialer is currently set to alert using siren and SVM1 and an input triggers a SVM2 request, then the number of repetitions will be reset and the dialer will dial again adding the new request to the alerts. This means that every time an input requests an alert not yet active, the dialer will re-dial, so no subscriber will miss the event.

DTMF control: At the end of 1st Siren/SVM cycle, the user will be prompted to enter a valid code; correct code enables access to the DTMF remote control functions.

7.4 Dialer reporting Programming locations

Zones to sound Siren via telephone 040 def 1234

Zones to activate SVM1 message 046----

Zones to activate SVM1 message 047----

Siren via telephone time seconds 053 def 10s

SVM1 via telephone time seconds 054 def 10s

SVM2 via telephone time seconds 055 def 10s

SVM1 is activated by the ON output of the board

SVM2 is activated by the A1 output of the board

There is no need for 072-7 "Enable Use of ON output as SVM trigger"

"ON" output is selected for SVM1 if there is at least one zone programmed at 046

"A1" output is selected for SVM2 if there is at least one zone programmed at 047

Other uses of ON and A1 are disabled if those outputs are selected for SVM1 and SVM2.

Note: The alerts are output in cycles siren followed by SVM1 followed by SVM2. The minimum call time is programmed at address 085. Program short times for each alert and a reasonable "minimum call time". This way, whoever picks the telephone will have a chance to listen to all alerts. For example:

Siren: 5 seconds

SVM1: 3 seconds (short message)

SVM2: 4 seconds

Total: 12 seconds

Minimum call time: 60 seconds. This means that the alerts will be present on the telephone line for at least 60 seconds (equivalent to 5 repetitions) and if the "user" picks the phone after 30 seconds he still has a chance to listen to the Siren, SVM1, SVM2.

Minimum call time - Seconds 085 def 60 (minimum 30s)

For pulse dialing:

"Make" time - 5 ms units 088 def 08

"Break" time - 5 ms units 089 def 12

Note: Make/Break time is in 5 ms units - unlike the units used in previous models of AV-3004/48

Note: Subscriber ID codes must be programmed for each CS number, also for Contact ID.

8. PROGRAMMING SHEET VERSION 1.06

Factory Default Program marked with (); Blank Square means no default program

① TELEPHONES & SMS Subscribers

TEST SIGNAL & AUTO ARMING TIME

SMS center	SMS Subsc'r 1	SMS Subsc'r 2	SMS Subsc'r 3	SMS Subsc'r 4	Telephone 1	Telephone 2
008	009	010	011	012	013	014
Telephone 3	Telephone 4	CS Tel 1	CS Tel 2	Not in use	Test Time	Auto Arm Time
015	016	017	018	019	004 (00:01)	006 00:00

Tel. 1 is also 'Follow Me'. Maximum 16 digits or # and *. At address 008 enter the provider SMS center number	Test signal to central station (004), enter time in 24 hour format. Codes are defined at Addresses: 052, 073, 237, 255
---	--

To insert * in the phone number; Program system to dial in DTMF, Hold-down keys # and * (as panic), 'A' will be displayed. If central phone add Pause during dialing hold-down key '0', add pause only at add 008, **not at** address 009, 010.

Zones 5-8 are applicable in 8 zone mode, default is 4 zones

② ZONE FEATURES

Feature	Address	1	2	3	4	5	6	7	8
Fire zones	019								
Zone In Use	020	1	2	3	4				
Entry/Exit Delay 1 (set at 060)	021	1							
Entry/Exit Delay 2 (set at 061)	022								
Entry / Exit Follower	023		2						
24-Hours Zone	024								
Day Zone	025								
Green Zone (one shot alarm)	026	1	2	3	4	5	6	7	8
Swinger Shut-Down	027								
Chime (set at 068)	028	1							
NO-EOL Resistor (not @ 8 zone mode)	029	1	2	3	4				
Enable Zone Tamper (not @ 8 zone mode)	030								
Delayed Power-Up	031								
Fast or Very Slow Response (set at 059)	032								
Group Bypass I (key 0 than 1)	033								
Group Bypass II (key 0 than 2) (auto arm)	034								
Manual Bypass (key 0 & zone number)	035	1	2	3	4	5	6	7	8
Siren Out	036	1	2	3	4	5	6	7	8
Alarm 1 (A1) Out	037	1	2	3	4	5	6	7	8
Reserved	038								
Reserved	039								
Dial on Alarm	040	1	2	3	4	5	6	7	8
Keypad sounder on Alarm	041	1	2	3	4	5	6	7	8
N.O. (normally open) zone	042								
Pulse count zone (only instant zone)	043								
Panic Zone	045								
Activate SVM message 1 via ON output	046								
Activate SVM message 2 via A1 output	047								

SVM1 is activated by the ON output; SVM2 is activated by the A1 output. For auto arming with group bypass use Group 2 only.

Keypad Panic Alarm	050
Siren on Panic	1
A1 output activate at Panic	2
Zone 4 / 8 (3044 PRO) as aux. key	3
Reserved	4
Telephone Report	(5)
Enable buzzer on Panic	6
Enable – 3 panics at AV-707B	7

Tamper Alarm	051
Tamper zone as 24H zone	1
A1 activated on Tamper	2
Tel. Line Test at Disarmed	3
Reserved	4
Tel. Line fail activates buzzer	5
Tel. Line fail activates siren	6
Dialer Report AC Power Fail	7

Address 052, CS test day: 1 - Sun 2 - Mon, 3 - Tues, 4 - Wed., 5 - Thu. 6 - Fri., 7 - Sat., 8 - All week's days, 0 - Clear all

<p>Key 1 – Hold down test siren Key 2 – Hold down display bypassed zones Key 3 – Hold down display troubled zone/s Key 6 than 5 hold down – Test SMS Key 6 than 7 hold down – Test dial by dialer Key 6 than 8 hold down – Test dial to C. Station</p>	<p>Set clock – Hold down 0 than 1, enter 4 digits HH:MM Set date - Hold down 0 than 6, enter 6 digits dd:mm:yy Enter to program mode – Hold down 8, than 1 9 9 4 than # Exit program mode – 999 than #, user program mode 99 # Keypad's # is the system ENTRE key</p>
---	--

③ TIME-OUTS

Siren sound before SVM	SVM 1 Message Length	SVM 2 Message Length	Pulse frame time (Max 30)	Open/Close Report CS	AC fail report delay	Zone Response time	Entry Delay 1	Entry Delay 2	Exit Delay	Siren Time	ON Siren Time	OFF Siren Time
Sec's	Sec's	Sec's	Sec's	00=No, 01=yes	Minutes	m. Sec	Sec's	Sec's x 4	Sec's x 4	Minutes	Sec's	Sec's
053	054	055	056	057	058	059	060	061	062	063	064	065
1 0	1 0	1 0	0 8	0 0	1 0	0 5	1 2	0 0	0 8	0 4	1 5	0 4

056 set for pulse count zone

A1 Time	Reserved	Chime Time	Abort Delay
Sec's	-	Beeps	Sec's
066	067	068	069
3 0	0 0	0 3	0 4

Notes: Address 059 adjusts the response time of zones selected as 'Fast Response'. If Slow Response selected at 075-4 than counts in minutes, the value in address 059 is multiplied by 4 and units are seconds, 63 is the maximum.

④ SYSTEM FEATURES – Values marked with () are the factory default programming

Feature	070
Enable-Siren/Bell Test upon Arming	1
Enable-Keypad 3 Beeps upon Disarming	(2)
Enable-Buzzer upon Entry Delay	(3)
Enable-Keypad Tactile Beep	(4)
Disable-4 LEDs display during Armed	5
Enable-Battery Test upon Arming	(6)
Reserved	7
Enable-Keypad Panic	(8)

Feature	071
Enable-Erase F. Me number on Disarm	1
Enable-Instant Arming via Key 5	2
Enable-Buzzer during exit delay	3
Enable-Display Alarmed Zone during alarm	4
Enable-Manual Bypass via Code No .1	5
Enable-Lock in Armed after Tamper Alarm	6
Enable-Momentary Key-Switch	(7)
Enable-Code '8' as one time code	8

Feature	072
Enable-Bell mode	(1)
Enable-Detailed alarm history	(2)
Enable-Report Opening/Closing	(3)
Activate ON output for ADSL filter line-cut	4
Enable-Report bypassed zones at Arming	(5)
Enable-Exit delay when delayed zones clear	6
Enable -'ON' output as SVM trigger *	7
Enable-codes reset to default by * & #	(8)

Feature	073
Enable-Display troubled zones at Disarmed	(1)
Enable-Test to central station each hour	2
Enable-Self contain Bell (0V at alarm) **	3
Reserved	4
Enable- Group Bypass when Arm with Key	5
Enable - 2 Siren Beeps at Key Disarming	6
Enable - A1 output time follows Siren time	(7)
Enable - Outputs (A1, ON) 0V at active	8

Feature	074
Reserved	1
Enable-Activate A1 via DTMF	2
Enable-Auto reset zone after alarm timeout	3
Reserved	4
Reserved	5
Enable – DTMF control via telephone	(6)
Enable – Bypass Answer Machine	7
Enable-Echo Cancellation Tone (AUSTEL)	8

Feature	075
Enable – K. Pad & Sir sounds @ Home mod	1
Enable – AV-3044 PRO New Zones Wiring way	2
Enable – Double report to central station	3
Enable – Slow response for address 032	4
Enable – Open/Close report by SMS	5
Enable – Listen In activated by A1 output	6
Enable – Strobe signal on/off via ON output	7
Enable - A1 output at Latching mode	8

Feature	076
Enable – PC Up and download via modem	1
Enable – Disarming via remote DTMF	2
Enable – Zone/s bypass via remote DTMF	3
Enable – Date/Time setting by remote PC	(4)
Enable – SMS reporting	(5)
Enable – Send the LOGO text as SMS header	6
Enable – Instant dial by Delay zone/s	7
Reserved	8

Not in use	077

Enable PC connection/Download via modem" - 076 - 1 (default not enabled). To access the panel via remote PC set 076-1. The panel will not accept a connection from a remote PC when it is ARMED or there was an alarm. When the panel is disarmed, a connection is always possible if the user entered the Answer Now command (hold down"6"+"1"). Using the PC connection one can only ARM the panel, but not disarm it.

When Arming, user can bypass some zones or set the Home Mode (group bypass). Zones bypassing is possible only if enabled at 076 - 3.

Enable Disarm via DTMF remote command- 076 - 2 (default not enabled).The panel can be accessed via telephone using DTMF commands when ARMED or DISARMED (if DTMF ENABLED at 074 - 6). The user can Disarm the panel using DTMF command only if option 076 – 2 is enabled.

Enable zones bypass by remote DTMF/PC- 076 - 3 (default NOT ENABLED). Zones can be bypassed by remote telephone or PC only if this option is enabled.

Enable date/time setting by remote PC - 076 - 4 (default ENABLED - meaning that the PC will SET the panel time and date at each connection). Setting this option will prevent the remote PC to modify and set panel's date and time.

Send logo text as SMS header – New for revision 1.02, logo text is sent as header for SMS (sent from Av-Gad, for example). See 076-6

⑤ DIAL PARAMETERS

Pre-Dial Delay	Wait for Dial Tone	Anti-Jam Delay	Dial tone detection	Dial Mode	Tel. MSG Time	Inter-Call Delay	Re-Dial Cycles (max.)	Pulse MAKE	Pulse BREAK	Inter Digit Delay	Rings qu't'y for modem	Instant modem answer	Ring Cycle Width
Sec's	Sec's	Sec's	00=No 01=Yes	0=Pulses 1=DTMF	Sec's	Sec's	XX Cycle	5 mS	5 mS	50 mS	Tel. Rings	00=No 01=Yes	100 mS (1-25)
080	081	082	083	084	085	086	087	088	089	090	091	092	093
0 0	0 4	1 0	0 0	0 1	5 0	2 0	0 3	0 8	1 2	2 0	1 0	0 1	2 0

Tel. Line Test Intervals	Min. Ring Length	Rings Time Out	SMS send trial
Minutes (Max 99)	10 mS (Max 20)	Seconds (4 to 25)	Units (1-5)
094	095	096	097
0 0	1 2	0 5	0 2

Dial tone detection address 083 is at 00 by default.

Note address 091: The download is ENABLED by default. Setting 21 at address 091 disable modem (because 21 ring for modem not accepted by telephone net). To ENABLE enter 01 to 20 at address 091 and 076-1. For Instant Modem Answer (Answer Now): Enter 01 in address 092, hold-down key 6 then hold-down key 1, 'A' displayed in confirmation. For special application, address 093 set the ring detector pulse width.

© **SET INSTALLER CODE:** Address 099 provides setting of installer code (default 1994)

⑦ **SET FACTORY DEFAULT:** In address 200 enter 6 9, program will revert to factory default programming

Ⓢ COMMUNICATOR (dials to central station) PARAMETERS (by default set Contact ID)

TELEPHONE	Receiver	Reserved	Handshake	Data Format	Protocol	Sum Check (Parity)	Transmit	Inter MSG	Wait for
CS Tel 1	Format 201		Frequency 203	205	Type 207	209	Rounds 211	Time 213	Handshake 215
	0 7		0 2	0 0	0 0	0 0	0 0	3 0	2 0

TELEPHONE	Receiver	Reserved	Handshake	Data Format	Protocol	Sum Check (Parity)	Transmit	Inter MSG	Wait for
CS Tel 2	Format 202		Frequency 204	206	Type 208	210	Rounds 212	Time 214	Handshake 216
	0 7		0 2	0 0	0 0	0 0	0 0	3 0	2 0

00 - Dialer only (No Communicator)	00=1400 Hz	00=3 X 1	00=Standard	00=None	00=2 Rnd	00=0.1 Sec	XX=Sec's
01 - Ademco, Silent Knight Slow, Scantronic	01=2300 Hz	01=4 X 1	01=Extend	01=S. Check	01=1 Rnd	30=3 Sec	
02 - Radionics Fast							
03 - SESCOA, Vertex, DCI, Franklin	02=Hi/Lo	02=4 X 2				3 Sec's is Default	
04 - Silent Knight Fast	Ademco H.S.						
05 - Radionics, DCI, Franklin Slow	SurGurd Rec.	03=3 X 2					
06 - Universal High Speed	set 00 or 01						
07 - Contact ID or Ademco High Speed *							

00 - 'No Communicator,' is identical to 'Dialer' that generates sound upon alarm. 'Rnd' is shortening for ROUNDS. 'S. Check' is shortening for 'Sum Check'. 'Hz' is shortening for 'Hertz' (frequency unit). When Contact ID selected program only Group 1 Subscriber ID at address 360 and 364.

Contact ID Format (known also as Ademco Express): This is the fastest to program and easiest to use format, with communication speed achieved by the DTMF signaling.

When using this format, program only the CS telephone numbers and subscriber ID; all reports automatically transmitted, without programming anything else.

To select the Contact ID format: In address 201 enter 07, same for address 202 is you need the back up reporting, enter the subscriber ID (refer to part 10 of programming table). Also enter the subscriber ID at address 360 and 364, must be 4 digits number.

In case the reporting fail try to change address 203 = 00, 204 = 00.

Ⓢ REPORT SELECTION

For communicator codes A to F, enter the following: A=10, B=11, C=12, D=13, E=14, F=15. Note: entering 0 0, is same as a blank.

Group 1				Group 2			
Report on Alarm 105				Report on Alarm 106			
1	2	3	4	<ZONE	AC	LB	PA
1	2	3	4	<VALUE	1	2	3
Zone Restore 107				Control Panel Restore 108			
1	2	3	4	<ZONE	AC	LB	PA
1	2	3	4	<VALUE	1	2	3
Report Bypassed Zones 109							
1	2	3	4	<ZONE			
1	2	3	4	<VALUE			

Ⓢ ALARM, RESTORE, BYPASS ZONES, OPENING / CLOSING, SIGNAL TEST & FORCE OPENING CODES

Group 1										Group 2										
Alarm Codes - Single Codes										Alarm Codes - Single Codes										
1	2	3	4							<ZONES (Alarm Code for Fire = 1)					AC	LB	PA			
110	112	114	116							<CODES>					126	128	130			
3	3	3	3												F	F	2			
111	113	115	117							<CODES>					127	129	131			
1	2	3	4												9	8	1			
Alarm Codes - Extended or 2 Digits										Alarm Codes - Extended or 2 Digits										

Restore Codes - Single Codes										Restore Codes - Single Codes										
1	2	3	4							<ZONES					AC	LB	PA			
142	144	146	148							<CODES>					158	160	162			
E	E	E	E												E	E	E			
143	145	147	149							<CODES>					159	161	163			
1	2	3	4												9	B	A			
Restore Codes - Extended or 2 Digits										Restore Codes - Extended or 2 Digits										

Bypassed Zones Codes - Single Codes										Reserved										
1	2	3	4							<ZONES										
174	176	178	180							<CODES>										
8	8	8	8																	
175	177	179	181							<CODES>										
1	2	3	4																	
Bypassed Zones - Extended or 2 Digits																				

Closing (Arming) Codes-Single Digit										Opening (Disarming) Codes-Single Digit										Single Digit				
1	2	3	4							<USER>					1	2	3	4					Test	Force
220	222	224	226							<CODE>					238	240	242	244					254	256
C	C	C	C												B	B	B	B					D	
221	223	225	227							<CODE>					239	241	243	245					255	257
1	2	3	4												1	2	3	4					9	
Closing Codes - Extended or 2 Digits										Opening Codes - Extended or 2 Digits														

In order to disable reporting Closing/Opening change program at address 072; remove value '3'.

When SIGNAL TEST is enabled, you can specify to report System Status (as default for Extended or 2 digits) by programming for example 'A' (Armed) at 236, and 'D' (Disarmed) at 254, '9' is the test signal code. For System Status report, select extended or two digits format.

For programming the End-User codes 1 to 8 (Arm/Disarm code) via installer programming mode, hold down 8 enter 1234, # program new codes by first entering the code index (1, 2, 3..8), enter the new required code than #, exit with 99 than # Entering the Disarming code in reverse order activates the Force Opening Code (Ambush) report to central station.

ⓈⓈ CS TEL. 1 - SUBSCRIBER ID NUMBER

Note: For subscriber ID that contains a '0' (zero), enter 10 in place of 0. '0' will be displayed as 'A.' Do not enter 0 0.

Group 1	Group 2
---------	---------

Alarm / Restore ID	Alarm / Restore ID	Open. / Closing ID									
260	261	262	263	268	269	270	271	276	277	278	279

To easily program the subscriber ID number, as a sequence of 4 digits use the EASY Program.

Even if your code is 3 digits only you must enter 4 digits, the 4th digit can be any digit and the system will disregard the 4th digit.

EASY Program				EASY Program				EASY Program			
Alarm / Restore ID				Alarm / Restore ID				Open. / Closing ID			
360				368				376			

CS TEL. 2 - SUBSCRIBER ID NUMBER

Group 1	Group 2
----------------	----------------

Alarm / Restore ID				Alarm / Restore ID				Open. / Closing ID			
264	265	266	267	272	273	274	275	280	281	282	283

EASY Program				EASY Program				EASY Program			
Alarm / Restore ID				Alarm / Restore ID				Open. / Closing ID			
364				372				380			

To easily program the subscriber ID number, as a sequence of 4 digits use the EASY Program.

Even if your code is 3 digits only you must enter 4 digits, the 4th digit can be any digit and the system will disregard the 4th digit.

Values beneath addresses are default programming.

8.1 Step - By - Step Programming

Entering Installer (Engineer) Programming Mode Via AV-706 or AV-707 Keypad

Easy Tip: You may program any address by entering the address, followed by the value in sequence. For LCD keypads **press #** (enter) to confirm the hold down command
Power up by connecting AC power.

1. Hold down keypad key  (hold-down function).
2. While four LED's are blinking enter programming code ('1 9 9 4')

    #

(the # is your Enter key, after each entry press #)

3. If code is valid 'Installer Progr.' will be displayed. The two left LED's (Red & Green) blink to indicate that system is waiting for a new address.
4. Enter the address you want to program (see programming sheet). Current value of address is displayed, and LEDs will blink.

Note: Blinking of 2 left most LEDs, means **system is waiting for new address to be entered;**

Enter a 3 or 2-digit address (according to address length.)

Note: 3 blinking LEDs means **system is waiting for new value to be entered;**

Enter a 2-digit value, or as required.

EXAMPLE 1:

System in program mode; 'Installer Progr.' is displayed and the two left-most LEDs are blinking.

1. Program zones 1 and 4 as 'Exit/Entry Delayed 1' zone.
2. Address 104 represents the 'Exit/Entry Delayed 1' zones.
3. Press #; current value of this address is '1' (default program.)
Three LEDs will blink and a 'Loc 104 1 - - - - -' will be displayed (default program).
4. To enter new required value press the address number > 104; followed by the new required value ('1' and '4') by pressing in uninterrupted sequence; new setting will be displayed to confirm 'Loc 104 1 - - 4 - - - -'

EXAMPLE 2:

1. Program zone 8 as 24H zone (in default, this is an Instant Zone).
2. Address 116 represents the 24H zones.
3. Press #; current value of the address is "Loc 116 - - - -
- - - -" ('-' means blank - no 24H zone is programmed).
4. To enter new required value press the address number #; cursor move to Upper raw, then enter new value '8,' by pressing
(zone 8); new setting will be displayed confirms programming updating.

Note: At programming enter '0' (zero) in order to delete a feature

EXAMPLE 3:

1. Program Siren Time for a 2-minute duration (default 4 minutes).
2. Address 063 represents the Siren Time.
3. Press #; current value of the address is 04;
Two LEDs blink and '04' will be displayed (default program).
4. Enter 063, then a new value of '02' by pressing #. New setting display, confirms programming updating.

9. Powering Up & Wiring Diagram

9.1 Before Powering Up

- Place Control Panel in a well-ventilated location and as far as possible from any heat, transmission and high humidity source.
- Do not place high power RF wireless transmitters near Control Panel.
- Check for proper grounding.
- Make sure detectors, keypads or any other devices are connected to the Control Panel in their correct polarities.
- Connect a momentary voltage to the siren; making sure a 'beep' is sounded. In case of no beep, check for a short circuit or improperly connected wires.
- Power-up through transformer, if system seems to operate properly connect the battery.
- Better do not connect any sensors or other devices to the battery terminals.
- Series 3000 is compatible with 12V smoke detectors, common collector type or relay (-) output on alarm, however, consider adding a manual Reset switch.

Momentary switch achieves smoke detector reset. The switch (or relay) disconnects power to smoke detector following a smoke alarm.

9.2 Wiring Diagram AV-3044 PRO Wiring Diagram

WARNING:
To prevent electrical shock, disengage the System and disconnect the telephone line before servicing this unit.

Auxiliary Power Output

Regulated 13.8V.
Observe maximum current-0.8A,
combined keypad and
Aux. power

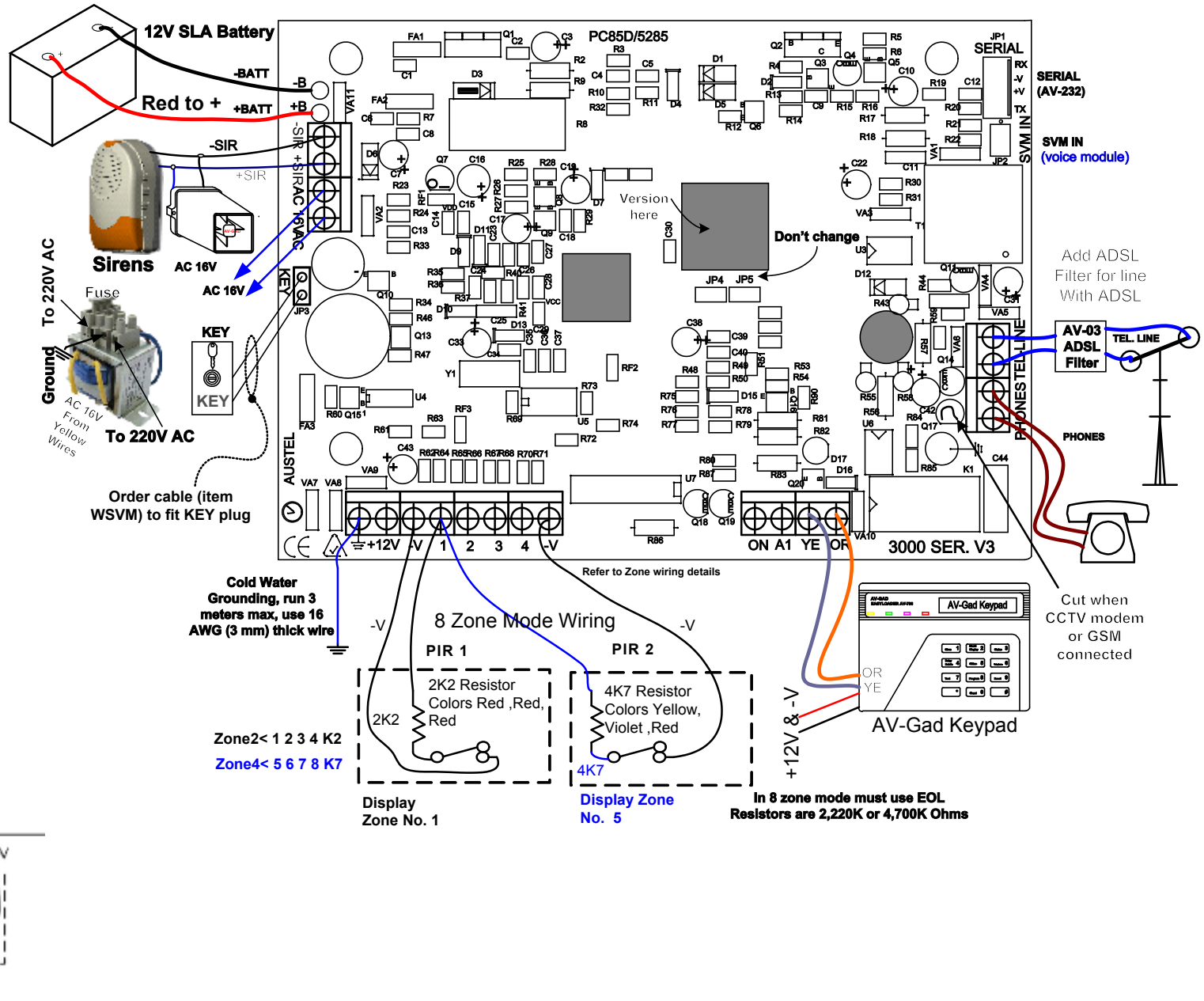

Figure 1: Optional 8 zones wiring in AV-3044 requires programming

